

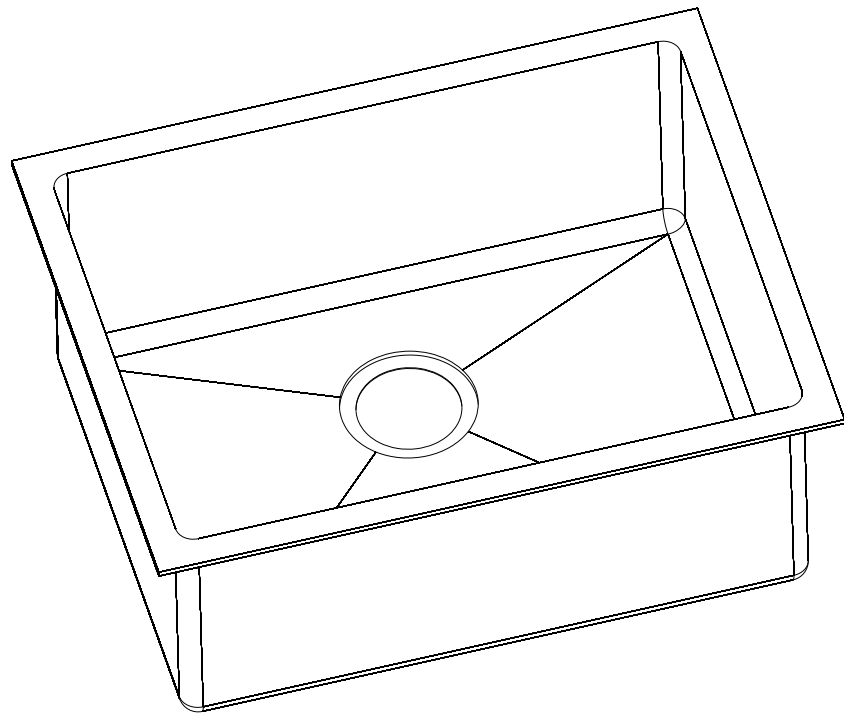

## Specifications

Model Number	Depth-Inches	Drain Placement	Model Specified
KH-2318-R15	10"	Back	



### SINK DESCRIPTION

- 1800 Series double bowl undermount sink
- 18 gauge stainless steel, Brushed finish
- Center drain location
- Mounting brackets included, other standard mounting hardware and silicone sealant not included
- SoundSHIELD sound absorbing system

### CUT OUT DIMENSIONS

Template included - template number KH-2318-R15

### STANDARDS

- Third party certified by IAPMO to meet ASME A112.19.3 and all applicable specifications referenced therein

### WARRANTY

- Limited lifetime warranty against material or manufacturing defects to the original consumer purchaser

### CRITICAL DIMENSIONS

(DO NOT SCALE)

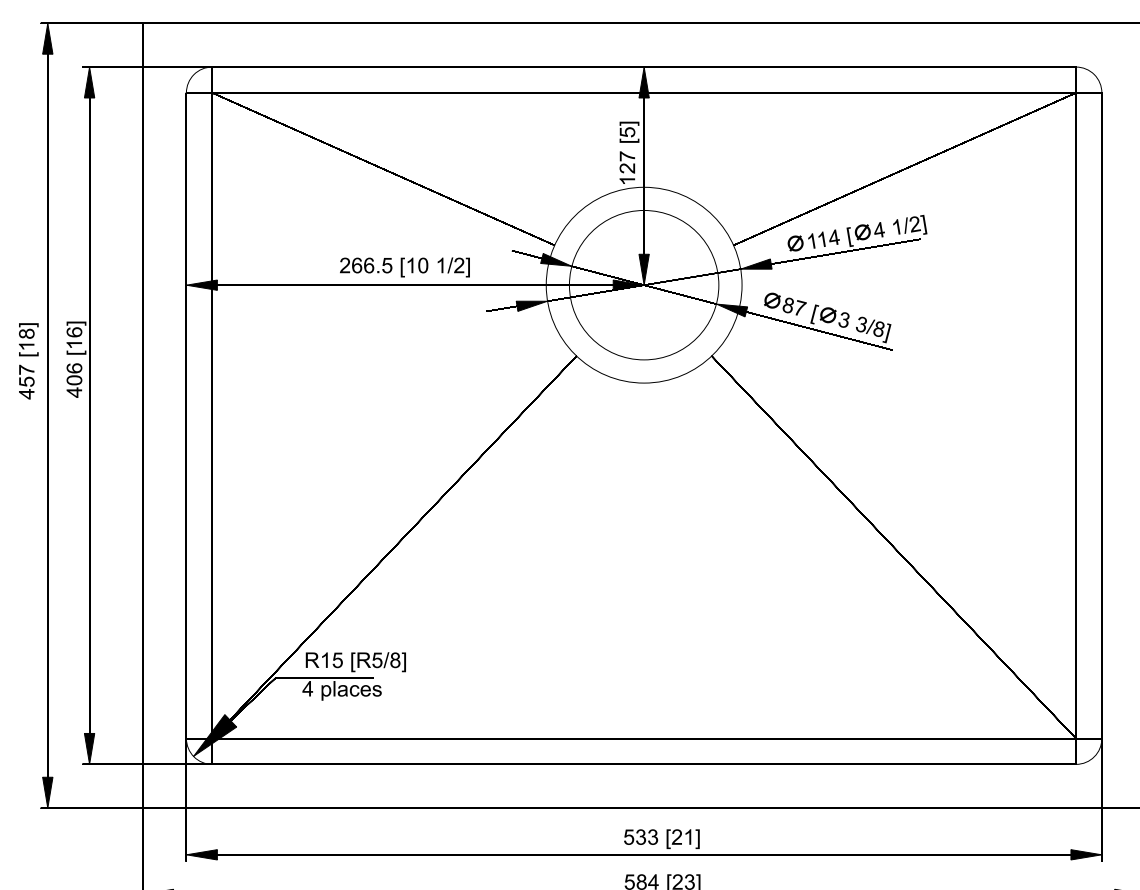

### Installation Detail

